

LISTINO PREZZI - Price List



M

A

X

+4%
da Settembre 2004
from September 2004

Della Rovere spa

CARATTERISTICHE TECNICHE

MAX

La nuova edizione del mod.MAX è realizzata in nobilitato melaminico e viene proposta nei colori noce, radica, ciliegio e palissandro, i cui piani e frontali sono verniciati con vernici in poliestere trattate con raggi ultravioletti (UV) ed anche nel colore antracite che è sempre in nobilitato con finitura antigraffio senza il trattamento di verniciatura.

Nelle finiture noce, radica ed antracite, gli elementi sono interamente bordati in massello di legno Ramin e MDF rivestito in color noce, mentre per il ciliegio ed il palissandro, i masselli sono in tinta con il colore dei mobili. Lo spessore dei top e dei fianchi scrivania è di m/m 50, mentre i top libreria, i fianchi di copertura, sono bordati con un massello di 28 m/m di spessore.

I contenitori dotati di piedini regolabili, sono realizzati in nobilitato color grigio antracite e presentano due larghezze e tre altezze con possibilità di sovrapposizione degli elementi. I fianchi di finitura sono disponibili in varie lunghezze: da due ante (cm .95) fino a sei ante (cm. 280). Le cassettiere su ruote sono dotate di un cassetto porta cancelleria e di una serratura centralizzata a chiusura simultanea. I cassetti sono montati su guide metalliche scorrevoli con rulli in nylon, garantendo un comodo e silenzioso scorrimento.

Poichè oggi, anche ai più alti livelli manageriali, è diventato necessario l'uso del computer, MAX offre la possibilità di avere un mobile di servizio attrezzato per l'informatica, risolvendo così numerosi problemi. Tutti i modelli sono forniti smontati ad esclusione delle cassettiere e dei mobili di servizio, ed imballati con cartone rigido e protezioni perimetrali corredati di ferramenta metallica ad applicazione rapida.

TECHNICAL CHARACTERISTICS

MAX

MAX

The new model MAX edition is made with ennobled melamine and it is proposed in walnut, briar wood, anthracite, cherry and rosewood colours. The tops and frontal panels are painted with polyester varnishes, treated with uv-rays, except for the anthracite colour, which has a scratch-resistant finishing without painting treatment.

In the walnut, briar wood and anthracite finishing, all units are bordered with true walnut-wood and mdf. The cherry and the rosewood finishing have their edge in the same colour of the tops.

The thickness of the desk tops and sides is of 50 mms., while the cabinet and pedestal tops, the external sides and the tops in general are bordered with true wood of 28 mms. thickness.

The cabinets, equipped with adjustable feet, are realized with anthracite ennobled wood and are available in two different widths and heights with the possibility of putting the elements one onto the other.

The external sides are realized in three different heights, while the tops in three lengths: as from 97 cms. (2 door-top) up to 277 cms. (6 door-top).

The mobile pedestals are equipped with a stationary drawer and with a central lock for a simultaneous closing. The drawers are set on metallic guides sliding on nylon rollers, and assuring perfect silence and fast slide.





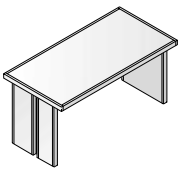
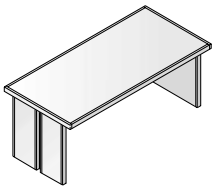
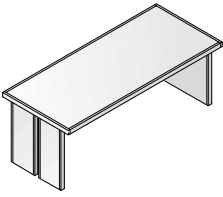
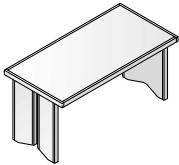
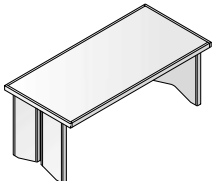
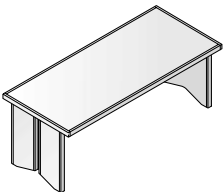

As the computer is nowadays part of the working life, MAX offers a useful credenzas, completely equipped for this purpose.

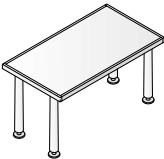
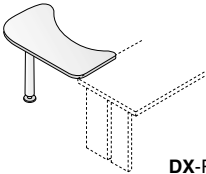
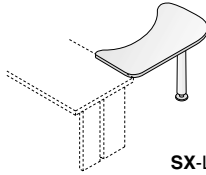
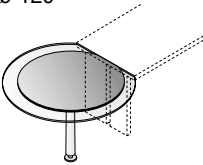
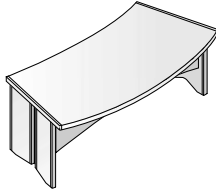
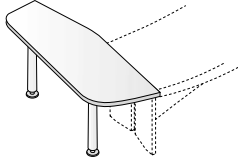
All items are supplied kd (knocked down), except for the drawer-units and the credenzas.

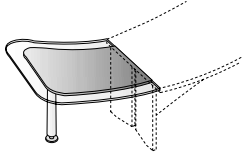
Packages are of stiff carton with perimetrical protections, and fitted with metallic hardware for quick application.

	ART. ITEM	DESCRIZIONE - DESCRIPTION		PREZZO - PRICE
 L160 P80 H75	PALISSANDRO D 215 4 00 CILIEGIO D 215 5 00 NOCE D 215 6 00 RADICA D 215 7 00 ANTRACITE D 215 8 00	SCRIVANIA CON FIANCO DIRITTO L. 160 - P. 80 - H. 75 DESK WITH LINEAR SIDES L. 160 - W. 80 - H. 75	Kg. 68 Mc. 0,180 Colli. 2 2 Packs	PALISSANDRO CILIEGIO NOCE RADICA € 365,65
				ANTRACITE € 332,60
 L190 P95 H75	PALISSANDRO D 215 4 02 CILIEGIO D 215 5 02 NOCE D 215 6 02 RADICA D 215 7 02 ANTRACITE D 215 8 02	SCRIVANIA CON FIANCO DIRITTO L. 190 - P. 95 - H. 75 DESK WITH LINEAR SIDES L. 190 - W. 95 - H. 75	Kg. 78 Mc. 0,190 Colli. 2 2 Packs	PALISSANDRO CILIEGIO NOCE RADICA € 391,47
				ANTRACITE € 353,26
 L210 P95 H75	PALISSANDRO D 215 4 04 CILIEGIO D 215 5 04 NOCE 215 6 04 RADICA 215 7 04 ANTRACITE 215 8 04	SCRIVANIA CON FIANCO DIRITTO L. 210 - P. 95 - H. 75 DESK WITH LINEAR SIDES L. 210 - W. 95 - H. 75	Kg. 85 Mc. 0,200 Colli. 2 2 Packs	PALISSANDRO CILIEGIO NOCE RADICA € 409,03
				ANTRACITE € 369,78
 L160 P80 H75	PALISSANDRO D 215 4 90 CILIEGIO D 215 5 90 NOCE D 215 6 90 RADICA D 215 7 90 ANTRACITE D 215 8 90	SCRIVANIA CON FIANCO SAGOMATO L. 160 - P. 80 - H. 75 DESK WITH SHAPED SIDES L. 160 - W. 80 - H. 75	Kg. 68 Mc. 0,180 Colli. 2 2 Packs	PALISSANDRO CILIEGIO NOCE RADICA € 394,57
				ANTRACITE € 361,52
 L190 P95 H75	PALISSANDRO D 215 4 91 CILIEGIO D 215 5 91 NOCE D 215 6 91 RADICA 215 7 91 ANTRACITE 215 8 91	SCRIVANIA CON FIANCO SAGOMATO L. 190 - P. 95 - H. 75 DESK WITH SHAPED SIDES L. 190 - W. 95 - H. 75	Kg. 78 Mc. 0,190 Colli. 2 2 Packs	PALISSANDRO CILIEGIO NOCE RADICA € 420,91
				ANTRACITE € 382,18
 L210 P95 H75	PALISSANDRO D 215 4 92 CILIEGIO D 215 5 92 NOCE D 215 6 92 RADICA D 215 7 92 ANTRACITE D 215 8 92	SCRIVANIA CON FIANCO SAGOMATO L. 210 - P. 95 - H. 75 DESK WITH SHAPED SIDES L. 210 - W. 95 - H. 75	Kg. 85 Mc. 0,200 Colli. 2 2 Packs	PALISSANDRO CILIEGIO NOCE RADICA € 437,96
				ANTRACITE € 399,22

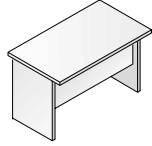
	ART. ITEM	DESCRIZIONE - DESCRIPTION		PREZZO - PRICE
 L130 P80 H75	PALISSANDRO D 215 4 13 CILIEGIO D 215 5 13 NOCE D 215 6 13 RADICA D 215 7 13 ANTRACITE D 215 8 13	TAVOLO DI SERVIZIO L. 130 - P. 80 - H. 75 SERVICE TABLE L. 130 - W. 80 - H. 75	Kg. Mc. Colli. 2 2 Packs	PALISSANDRO CILIEGIO NOCE RADICA € 350,16
				ANTRACITE € 329,50
PER SCRIVANIE DIRITTE E CURVE FOR CURVED AND LINEAR DESKS  DX-RH	ANTRACITE D 215 8 93	PENISOLA IN MDF DX PER SCRIVANIA DIRITTA E CURVA L. 125 - P. 77 - H. 75 RH RETURN IN MDF FOR CURVED AND LINEAR DESKS L. 125 - W. 77 - H. 75	Kg. 20 Mc. Colli. 2 2 Packs	€ 270,11
PER SCRIVANIE DIRITTE E CURVE FOR CURVED AND LINEAR DESKS  SX-LH	ANTRACITE D 215 8 94	PENISOLA IN MDF SX PER SCRIVANIA DIRITTA E CURVA L. 125 - P. 77 - H. 75 LH RETURN IN MDF FOR CURVED AND LINEAR DESKS L. 125 - W. 77 - H. 75	Kg. 20 Mc. Colli. 2 2 Packs	€ 270,11
ø 120  NON É APPLICABILE SU SCRIVANIA L. 160 UNFIT 160 CMS. DESK	D 0250504	PENISOLA IN CRISTALLO ø 120 CRYSTAL CONFERENCE END TABLE ø 120	Kg. 47 Mc. 0,098 Colli. 3 3 Packs	€ 336,21
 L220 P106 H75	PALISSANDRO D 215 4 05 CILIEGIO D 215 5 05 NOCE D 215 6 05 RADICA D 215 7 05 ANTRACITE D 215 8 05	SCRIVANIA CURVA L. 220 - P. 106 - H. 75 CURVED DESK L. 220 - W. 106 - H. 75	Kg. 88 Mc. 0,240 Colli. 2 2 Packs	PALISSANDRO CILIEGIO NOCE RADICA € 588,76
				ANTRACITE € 539,18
REVERSIBILE REVERSIBLE  SOLO PER SCRIVANIA CURVA FOR CURVED DESK, ONLY	ANTRACITE D 215 8 95 REVERSIBILE REVERSIBLE	ALLUNGO IN MDF DX E SX PER SCRIVANIA CURVA L. 210 - P. 62 - H. 75 RX/LH RETURN IN MDF FOR CURVED DESK L. 210 - W. 62 - H. 75	Kg. 50 Mc. Colli. 3 3 Packs	€ 416,26

	ART. ITEM	DESCRIZIONE - DESCRIPTION		PREZZO - PRICE
 SOLO PER SCRIVANIE CURVE FOR CURVED DESKS, ONLY	D 0250500	PENISOLA IN CRISTALLO CURVA L. 98 - P. 114 CURVED CRYSTAL CONFERENCE END TABLE L. 98 - W. 114	Kg. 51 Mc. 0,120 Colli. 3 3 Packs	€ 336,21
 L42 P56 H60	PALISSANDRO D 215 4 06 CILIEGIO D 215 5 06 NOCE D 215 6 06 RADICA D 215 7 06 ANTRACITE D 215 8 06	CASSETTIERA A 4 CASSETTI SU RUOTE CON CHIUSURA SIMULTANEA L. 42 - P. 56 - H. 60 4 DRAWER PEDESTAL ON CASTORS WITH CENTRALIZED LOCK L. 42 - W. 56 - H. 60	Kg. 26 Mc. 0,150 Colli. 1 1 Pack	PALISSANDRO CILIEGIO NOCE RADICA € 199,35 ANTRACITE € 193,15
 L42 P56 H60	PALISSANDRO D 215 4 08 CILIEGIO D 215 5 08 NOCE D 215 6 08 RADICA D 215 7 08 ANTRACITE D 215 8 08	CLASSIFICATORE SU RUOTE CON CHIUSURA SIMULTANEA L. 42 - P. 56 - H. 60 FILING CABINET ON CASTORS WITH CENTRALIZED LOCK L. 42 - W. 56 - H. 60	Kg. 25 Mc. 0,150 Colli. 1 1 Pack	PALISSANDRO CILIEGIO NOCE RADICA € 209,68 ANTRACITE € 203,48
 L126 P52 H67	PALISSANDRO D 215 4 12 CILIEGIO D 215 5 12 NOCE D 215 6 12 RADICA D 215 7 12 ANTRACITE D 215 8 12	MOBILE DI SERVIZIO L. 126 - P. 52 - H. 67 CREDENZA L. 126 - W. 52 - H. 67	Kg. 64 Mc. 0,450 Colli. 1 1 Pack	PALISSANDRO CILIEGIO NOCE RADICA € 355,84 ANTRACITE € 346,03
 L117 P58 H65	PALISSANDRO D 215 4 10 CILIEGIO D 215 5 10 NOCE D 215 6 10 RADICA D 215 7 10 ANTRACITE D 215 8 10	TAVOLO DATTILO L. 117 - P. 58 - H. 65 TYPING DESK L. 117 - W. 58 - H. 65	Kg. 24 Mc. 0,067 Colli. 1 1 Pack	PALISSANDRO CILIEGIO NOCE RADICA € 157,52 ANTRACITE € 141,51
	D 0210113	CASSETTIERA DATTILO L. 25 - P. 40 - H. 22 TYPING PEDESTAL L. 25 - W. 40 - H. 22	Kg. 3 Mc. 0,025 Colli. 1 1 Pack	€ 27,89

TAVOLI RIUNIONE Spessore mm 51
Meeting tables Thickness 51 mms

MAX

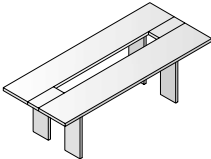
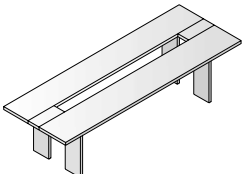
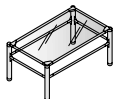
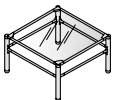
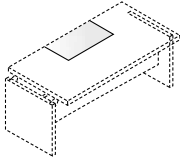
	ART. ITEM	DESCRIZIONE - DESCRIPTION		PREZZO - PRICE
 L250 P124 H75	PALISSANDRO D 215 4 16 CILIEGIO D 215 5 16 NOCE D 215 6 16 RADICA D 215 7 16 ANTRACITE D 215 8 16	TAVOLO RIUNIONE L. 250 - P. 124 - H. 75 MEETING TABLE L. 250 - W. 1240 - H. 75	Kg. 97 Mc. 0,298 Colli. 5 5 Packs	PALISSANDRO CILIEGIO NOCE RADICA € 671,39
				ANTRACITE € 619,23
 L300 P124 H75	PALISSANDRO D 215 4 18 CILIEGIO D 215 5 18 NOCE D 215 6 18 RADICA D 215 7 18 ANTRACITE D 215 8 18	TAVOLO RIUNIONE L. 300 - P. 124 - H. 75 MEETING TABLE L. 300 - W. 1240 - H. 75	Kg. 109 Mc. 0,340 Colli. 5 Packs	PALISSANDRO CILIEGIO NOCE RADICA € 736,47
				ANTRACITE € 680,69
 L91 P53 H43	D 0210111	TAVOLO DA CAFFE' STRUTTURA IN METALLO PIANO IN VETRO FUME' L. 91 - P. 53 - H. 43 COFFEE TABLE-METAL STRUCTURE GLASS PLATE L. 91 - W. 53 - H. 43	Kg. 18 Mc. 0,075 Colli. 1 1 Pack	€ 161,65
 L76 P76 H43	D 0210112	TAVOLO DA CAFFE' STRUTTURA IN METALLO PIANO IN VETRO FUME' L. 76 - P. 76 - H. 43 COFFEE TABLE-METAL STRUCTURE GLASS PLATE L. 76 - W. 76 - H. 43	Kg. 18 Mc. 0,085 Colli. 1 1 Pack	€ 161,65
 L70 P40	NERO/BLACK D 218000	SOTTOMANO IN PELLE UNIVERSALE L. 70 - P. 40 UNIVERSAL LEATHER DESK-PAD L. 70 - W. 40	Kg. 1 Mc. 0,005 Colli. 1 1 Pack	€ 49,58

Palissandro Rosewood - Ciliegio Cherry - Noce Walnut - Radica Briar Wood - Antracite Anthracite

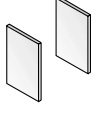
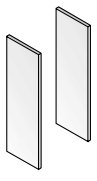
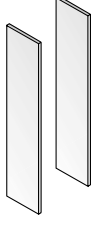
	<i>ART. ITEM</i>	<i>DESCRIZIONE - DESCRIPTION</i>		<i>PREZZO - PRICE</i>
 L2,5 P45 H71	PALISSANDRO D 215 4 68 CILIEGIO D 215 5 68 NOCE D 215 6 68 ANTRACITE D 215 8 68	COPPIA FIANCHI FINALI BASSI H. 71 - P. 45 - L. 2.5 LOW FINISHING SIDES H. 71 - W. 45 - L. 2.5	Kg. 12 Mc. 0,027 Colli. 1 1 Pack	PALISSANDRO CILIEGIO NOCE € 58,88
				ANTRACITE € 48,03
 L2,5 P45 H140	PALISSANDRO D 215 4 70 CILIEGIO D 215 5 70 NOCE D 215 6 70 ANTRACITE D 215 8 70	COPPIA FIANCHI FINALI MEDI H. 140 - P. 45 - L. 2.5 MEDIUM FINISHING SIDES H. 140 - W. 45 - L. 2.5	Kg. 24 Mc. 0,052 Colli. 1 1 Pack	PALISSANDRO CILIEGIO NOCE € 94,51
				ANTRACITE € 76,44
 L2,5 P45 H210	PALISSANDRO D 215 4 72 CILIEGIO D 215 5 72 NOCE D 215 6 72 ANTRACITE D 215 8 72	COPPIA FIANCHI FINALI ALTI H. 208 - P. 45 - L. 2.5 HIGH FINISHING SIDES H. 208 - W. 45 - L. 2.5	Kg. 35 Mc. 0,073 Colli. 1 1 Pack	PALISSANDRO CILIEGIO NOCE € 134,80
				ANTRACITE € 107,94

N.B. - Per le composizioni effettuate con Max Radica, si devono applicare i fianchi e i top in finitura Antracite.
N.B. - For compositions of Max Briarwood, you have to add finishing sides and tops in Anthracite colour.

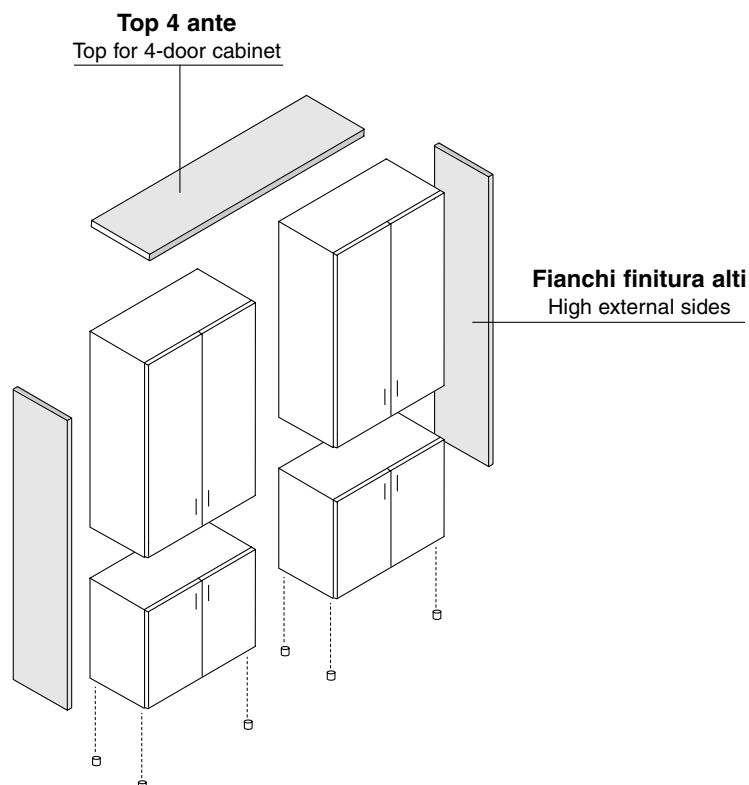

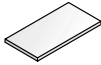
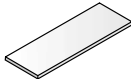
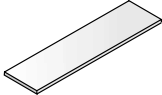
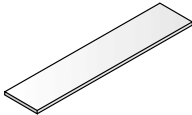
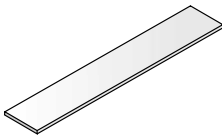

	<i>ART. ITEM</i>	<i>DESCRIZIONE - DESCRIPTION</i>		<i>PREZZO - PRICE</i>
 L97 P48 H2.5	PALISSANDRO D 215 4 74 CILIEGIO D 215 5 74 NOCE D 215 6 74 ANTRACITE D 215 8 74	TOP 2 ANTE L. 97 - P. 48 - H. 2.8 TOP FOR 2-DOOR CABINET L. 97 - W. 48 - H. 2.8	Kg. 8 Mc. 0,018 Colli. 1 1 Pack	PALISSANDRO CILIEGIO NOCE € 51,65
				ANTRACITE € 44,42
 L142 P48 H2.5	PALISSANDRO D 215 4 76 CILIEGIO D 215 5 76 NOCE D 215 6 76 ANTRACITE D 215 8 76	TOP 3 ANTE L. 142 - P. 48 - H. 2.8 TOP FOR 3-DOOR CABINET L. 142 - W. 48 - H. 2.8	Kg. 13 Mc. 0,029 Colli. 1 1 Pack	PALISSANDRO CILIEGIO NOCE € 65,59
				ANTRACITE € 55,78
 L187 P48 H2.5	PALISSANDRO D 215 4 78 CILIEGIO D 215 5 78 NOCE D 215 6 78 ANTRACITE D 215 8 78	TOP 4 ANTE L. 187 - P. 48 - H. 2.8 TOP FOR 4-DOOR CABINET L. 187 - W. 48 - H. 2.8	Kg. 17 Mc. 0,038 Colli. 1 1 Pack	PALISSANDRO CILIEGIO NOCE € 77,47
				ANTRACITE € 65,59
 L232 P48 H2.5	PALISSANDRO D 215 4 80 CILIEGIO D 215 5 80 NOCE D 215 6 80 ANTRACITE D 215 8 80	TOP 5 ANTE L. 232 - P. 48 - H. 2.8 TOP FOR 5-DOOR CABINET L. 232 - W. 48 - H. 2.8	Kg. 21 Mc. 0,048 Colli. 1 1 Pack	PALISSANDRO CILIEGIO NOCE € 90,90
				ANTRACITE € 74,89
 L277 P48 H2.5	PALISSANDRO D 215 4 82 CILIEGIO D 215 5 82 NOCE D 215 6 82 ANTRACITE D 215 8 82	TOP 6 ANTE L. 277 - P. 48 - H. 2.8 TOP FOR 6-DOOR CABINET L. 277 - W. 48 - H. 2.8	Kg. 25 Mc. 0,057 Colli. 1 1 Pack	PALISSANDRO CILIEGIO NOCE € 105,36
				ANTRACITE € 86,25

Palissandro Rosewood - Ciliegio Cherry - Noce Walnut - Radica Briar Wood - Antracite Anthracite

TOP PER ELEMENTI CENTRALI MENSOLE

Top for Central Units and Shelves

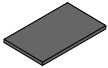
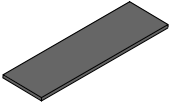

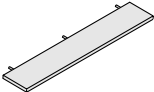

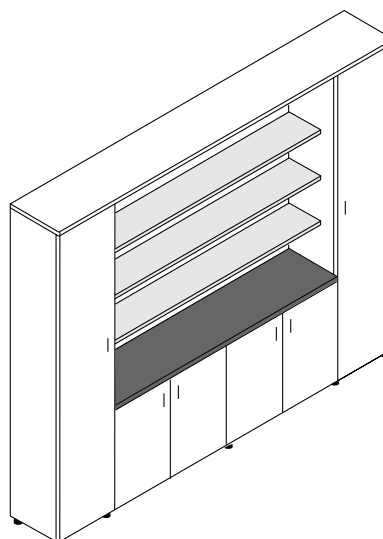
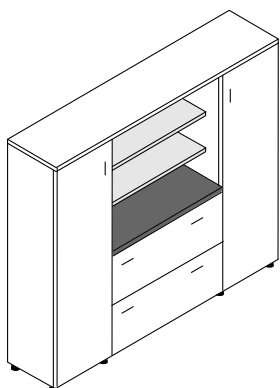

MAX

	ART. ITEM	DESCRIZIONE - DESCRIPTION		PREZZO - PRICE
 L90 P48 H2.5	PALISSANDRO D 215 4 84 CILIEGIO D 215 5 84 NOCE D 215 6 84 ANTRACITE D 215 8 84	TOP PER ELEMENTI CENTRALI DA 90 L. 90 - P. 47 - H. 2.5 TOP FOR 90 CMS. CENTRAL UNITS L. 90 - W. 47 - H. 2.5	Kg. 8 Mc. 0,018 Colli. 1 1 Pack	PALISSANDRO CILIEGIO NOCE € 50,10
				ANTRACITE € 40,80
 L180 P48 H2.5	PALISSANDRO D 215 4 85 CILIEGIO D 215 5 85 NOCE D 215 6 85 ANTRACITE D 215 8 85	TOP PER ELEMENTI CENTRALI DA 180 L. 180 - P. 47 - H. 2.5 TOP FOR 180 CMS. CENTRAL UNITS L. 180 - W. 47 - H. 2.5	Kg. 17 Mc. 0,038 Colli. 1 1 Pack	PALISSANDRO CILIEGIO NOCE € 73,34
				ANTRACITE € 66,11
 L90 P30 H2.5	PALISSANDRO D 215 4 86 CILIEGIO D 215 5 86 NOCE D 215 6 86 ANTRACITE D 215 8 86	MENSOLA A MURO CON SUPPORTI DA 90 CM. L. 90 - P. 30 - H. 2.5 90 CMS. WALL SHELF WITH STIRRUPS L. 90 - W. 30 - H. 2.5	Kg. 9 Mc. 0,02 Colli. 2 2 Packs	PALISSANDRO CILIEGIO NOCE ANTRACITE € 62,49
 L180 P30 H2.5	PALISSANDRO D 215 4 87 CILIEGIO D 215 5 87 NOCE D 215 6 87 ANTRACITE D 215 8 87	MENSOLA A MURO CON SUPPORTI DA 180 CM. L. 180 - P. 30 - H. 2.5 180 CMS. WALL SHELF WITH STIRRUPS L. 180 - W. 30 - H. 2.5	Kg. 18 Mc. 0,04 Colli. 2 2 Packs	PALISSANDRO CILIEGIO NOCE ANTRACITE € 93,48

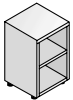

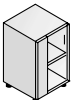

Esempi di composizione.



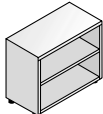
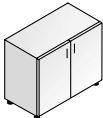
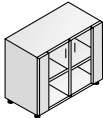
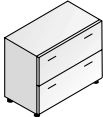
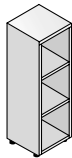

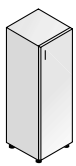
Composition Examples.

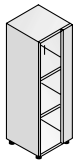
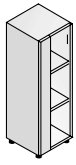
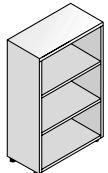



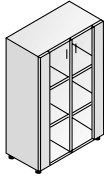
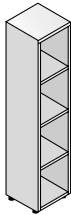

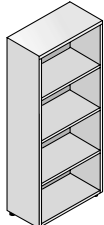

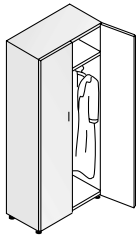

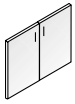

	ART. ITEM	DESCRIZIONE - DESCRIPTION		PREZZO - PRICE
 L45 P44 H73	ANTRACITE D 0240773	CONTENITORE BASSO A GIORNO L. 45 - P. 44 - H. 73 LOW OPEN SHELF CABINET L. 45 - W. 44 - H. 73	Kg. 19 Mc. 0,043 Colli. 1 1 Pack	€ 68,17
 L45 P46 H73 DX - RH	PALISSANDRO D 215 4 19 CILIEGIO D 215 5 19 NOCE D 215 6 19 RADICA D 215 7 19 ANTRACITE D 215 8 19	CONTENITORE BASSO CON ANTA LEGNO DX L. 45 - P. 46 - H. 73 LOW CABINET WITH RH WOODEN DOOR L. 45 - W. 46 - H. 73	Kg. 23 Mc. 0,063 Colli. 2 2 Pack	PALISSANDRO CILIEGIO NOCE RADICA € 99,68 ANTRACITE € 94,00
 L45 P46 H73 SX - LH	PALISSANDRO D 215 4 20 CILIEGIO D 215 5 20 NOCE D 215 6 20 RADICA D 215 7 20 ANTRACITE D 215 8 20	CONTENITORE BASSO CON ANTA LEGNO SX L. 45 - P. 46 - H. 73 LOW CABINET WITH LH WOODEN DOOR L. 45 - W. 46 - H. 73	Kg. 23 Mc. 0,063 Colli. 2 2 Packs	PALISSANDRO CILIEGIO NOCE RADICA € 99,68 ANTRACITE € 94,00
 L45 P46 H73 DX - RH	PALISSANDRO D 215 4 21 CILIEGIO D 215 5 21 NOCE D 215 6 21 RADICA D 215 7 21 ANTRACITE D 215 8 21	CONTENITORE BASSO CON ANTA IN VETRO DX L. 45 - P. 46 - H. 73 LOW CABINET WITH RH GLASS DOOR L. 45 - W. 46 - H. 73	Kg. 23 Mc. 0,063 Colli. 2 2 Packs	PALISSANDRO CILIEGIO NOCE RADICA ANTRACITE € 109,49
 L45 P46 H73 SX - LH	PALISSANDRO D 215 4 22 CILIEGIO D 215 5 22 NOCE D 215 6 22 RADICA D 215 7 22 ANTRACITE D 215 8 22	CONTENITORE BASSO CON ANTA IN VETRO SX L. 45 - P. 46 - H. 73 LOW CABINET WITH LH GLASS DOOR L. 45 - W. 46 - H. 73	KKg. 23 Mc. 0,063 Colli. 2 2 Packs	PALISSANDRO CILIEGIO NOCE RADICA ANTRACITE € 109,49
SOLO PER LIBRERIE FOR CABINET COMPOSITIONS, ONLY  L45 P46 H73	PALISSANDRO D 215 4 24 CILIEGIO D 215 5 24 NOCE D 215 6 24 RADICA D 215 7 24 ANTRACITE D 215 8 24	MOBILE BASSO CON 4 CASSETTI L. 45 - P. 46 - H. 73 LOW CABINET WITH 4 DRAWERS L. 45 - W. 46 - H. 73	Kg. 27 Mc. 0,160 Colli. 1 1 Pack	PALISSANDRO CILIEGIO NOCE RADICA € 160,62 ANTRACITE € 153,39

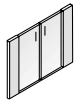

	ART. ITEM	DESCRIZIONE - DESCRIPTION		PREZZO - PRICE
SOLO PER LIBRERIE FOR CABINET COMPOSITIONS, ONLY  L45 P46 H73	PALISSANDRO D 215 4 26 CILIEGIO D 215 5 26 NOCE D 215 6 26 RADICA D 215 7 26 ANTRACITE D 215 8 26	MOBILE BASSO CON 2 CLASSIFICATORI L. 45 - P. 46 - H. 73 LOW CABINET WITH 2 FILING DRAWERS L. 45 - W. 46 - H. 73	Kg. 24 Mc. 0,160 Colli. 1 1 Pack	PALISSANDRO CILIEGIO NOCE RADICA € 215,88
				ANTRACITE € 208,65
 L90 P44 H73	ANTRACITE D 0240778	CONTENITORE BASSO A GIORNO L. 90 - P. 44 - H. 73 LOW OPEN SHELF CABINET L. 90 - W. 44 - H. 73	Kg. 27 Mc. 0,075 Colli. 1 1 Pack	€ 90,90
CON SERRATURA WITH LOCK  L90 P46 H73	PALISSANDRO D 215 4 28 CILIEGIO D 215 5 28 NOCE D 215 6 28 RADICA D 215 7 28 ANTRACITE D 215 8 28	CONTENITORE BASSO CON 2 ANTE IN LEGNO L. 90 - P. 46 - H. 73 LOW CABINET WITH 2 WOODEN DOORS L. 90 - W. 46 - H. 73	Kg. 35 Mc. 0,097 Colli. 2 2 Packs	PALISSANDRO CILIEGIO NOCE RADICA € 155,97
				ANTRACITE € 144,09
SENZA SERRATURA WITHOUT LOCK  L90 P46 H73	PALISSANDRO D 215 4 30 CILIEGIO D 215 5 30 NOCE D 215 6 30 RADICA D 215 7 30 ANTRACITE D 215 8 30	CONTENITORE BASSO CON 2 ANTE VETRO L. 90 - P. 46 - H. 73 LOW CABINET WITH 2 GLASS DOORS L. 90 - W. 46 - H. 73	Kg. 35 Mc. 0,097 Colli. 2 2 Packs	PALISSANDRO CILIEGIO NOCE RADICA ANTRACITE € 168,88
 L90 P46 H73	PALISSANDRO D 215 4 32 CILIEGIO D 215 5 32 NOCE D 215 6 32 RADICA D 215 7 32 ANTRACITE D 215 8 32	MOBILE BASSO CON 2 CLASSIFICATORI L. 90 - P. 46 - H. 73 LOW CABINET WITH 2 FILING DRAWERS L. 90 - W. 46 - H. 73	Kg. 45 Mc. 0,330 Colli. 1 1 Pack	PALISSANDRO CILIEGIO NOCE RADICA € 264,43
				ANTRACITE € 250,48
 L45 P44 H141	ANTRACITE D 0240782	CONTENITORE MEDIO A GIORNO L. 45 - P. 44 - H. 141 MEDIUM OPEN SHELF CABINET L. 45 - W. 44 - H. 141	Kg. 31 Mc. 0,070 Colli. 1 1 Pack	€ 98,64

	<i>ART. ITEM</i>	<i>DESCRIZIONE - DESCRIPTION</i>		<i>PREZZO - PRICE</i>
 L45 P46 H141 DX - RH	PALISSANDRO D 215 4 34 CILIEGIO D 215 5 34 NOCE D 215 6 34 RADICA D 215 7 34 ANTRACITE D 215 8 34	CONTENITORE MEDIO CON ANTA IN LEGNO DX L. 45 - P. 46 - H. 141 MEDIUM CABINET WITH RH WOODEN DOOR L. 45 - W. 46 - H. 141	Kg. 40 Mc. 0,099 Colli. 2 2 Packs	PALISSANDRO CILIEGIO NOCE RADICA € 150,81
				ANTRACITE € 132,73
 L45 P46 H141 SX - LH	PALISSANDRO D 215 4 35 CILIEGIO D 215 5 35 NOCE D 215 6 35 RADICA D 215 7 35 ANTRACITE D 215 8 35	CONTENITORE MEDIO CON ANTA IN LEGNO SX L. 45 - P. 46 - H. 141 MEDIUM CABINET WITH LH WOODEN DOOR L. 45 - W. 46 - H. 141	Kg. 40 Mc. 0,099 Colli. 2 2 Packs	PALISSANDRO CILIEGIO NOCE RADICA € 150,81
				ANTRACITE € 132,73
 L45 P46 H141 DX - RH	PALISSANDRO D 215 4 36 CILIEGIO D 215 5 36 NOCE D 215 6 36 RADICA D 215 7 36 ANTRACITE D 215 8 36	CONTENITORE MEDIO CON ANTA IN VETRO DX L. 45 - P. 46 - H. 141 MEDIUM CABINET WITH RH GLASS DOOR L. 45 - W. 46 - H. 141	Kg. 40 Mc. 0,099 Colli. 2 2 Packs	PALISSANDRO CILIEGIO NOCE RADICA ANTRACITE € 161,65
 L45 P46 H141 SX - LH	PALISSANDRO D 215 4 37 CILIEGIO D 215 5 37 NOCE D 215 6 37 RADICA D 215 7 37 ANTRACITE D 215 8 37	CONTENITORE MEDIO CON ANTA IN VETRO SX L. 45 - P. 46 - H. 141 MEDIUM CABINET WITH LH GLASS DOOR L. 45 - W. 46 - H. 141	Kg. 40 Mc. 0,099 Colli. 2 2 Packs	PALISSANDRO CILIEGIO NOCE RADICA ANTRACITE € 161,65
 L90 P44 H141	ANTRACITE D 0240785	CONTENITORE MEDIO A GIORNO L. 90 - P. 44 - H. 141 MEDIUM OPEN SHELF CABINET L. 90 - W. 44 - H. 141	Kg. 41 Mc. 0,113 Colli. 1 1 Pack	€ 131,70
 L90 P46 H141	PALISSANDRO D 215 4 40 CILIEGIO D 215 5 40 NOCE D 215 6 40 RADICA D 215 7 40 ANTRACITE D 215 8 40	CONTENITORE MEDIO CON 2 ANTE IL LEGNO L. 90 - P. 46 - H. 141 MEDIUM CABINET WITH 2 WOODEN DOORS L. 90 - W. 46 - H. 141	Kg. 59 Mc. 0,157 Colli. 2 2 Packs	PALISSANDRO CILIEGIO NOCE RADICA € 228,27
				ANTRACITE € 190,06

	ART. ITEM	DESCRIZIONE - DESCRIPTION		PREZZO - PRICE
 L90 P46 H141	PALISSANDRO D 215 4 42 CILIEGIO D 215 5 42 NOCE D 215 6 42 RADICA D 215 7 42 ANTRACITE D 215 8 42	CONTENITORE MEDIO CON 2 ANTE IN VETRO L. 90 - P. 46 - H. 141 MEDIUM CABINET WITH 2 GLASS DOORS L. 90 - W. 46 - H. 141	Kg. 58 Mc. 0,157 Colli. 2 2 Packs	PALISSANDRO CILIEGIO NOCE RADICA ANTRACITE € 252,03
 L45 P44 H210	ANTRACITE D 0240790	CONTENITORE ALTO A GIORNO CON 4 RIPIANI L. 45 - P. 44 - H. 210 HIGH OPEN SHELF CABINET WITH 4 SHELVES L. 45 - W. 44 - H. 210	Kg. 42 Mc. 0,110 Colli. 1 1 Pack	€ 183,34
 L45 P46 H210	PALISSANDRO D 215 4 96 CILIEGIO D 215 5 96 NOCE D 215 6 96 RADICA D 215 7 96 ANTRACITE D 215 8 96	CONTENITORE ALTO CON ANTA IN LEGNO E 4 RIPIANI L. 45 - P. 46 - H. 210 HIGH CABINET WITH WOODEN DOOR AND 4 SHELVES L. 45 - W. 46 - H. 210	Kg. 55 Mc. 0,152 Colli. 2 2 Packs	PALISSANDRO CILIEGIO NOCE RADICA € 290,77 ANTRACITE € 257,20
 L90 P44 H210	ANTRACITE D 0240791	CONTENITORE ALTO A GIORNO CON 4 RIPIANI L. 90 - P. 44 - H. 210 HIGH OPEN SHELF CABINET WITH 4 SHELVES L. 90 - W. 44 - H. 210	Kg. 66 Mc. 0,215 Colli. 2 2 Packs	€ 248,42
 L90 P46 H210	PALISSANDRO D 215 4 97 CILIEGIO D 215 5 97 NOCE D 215 6 97 RADICA D 215 7 97 ANTRACITE D 215 8 97	CONTENITORE ALTO CON ANTE IN LEGNO E 4 RIPIANI L. 90 - P. 46 - H. 210 HIGH CABINET WOODEN DOORS AND 4 SHELVES L. 90 - W. 46 - H. 210	Kg. 80 Mc. 0,270 Colli. 3 3 Packs	PALISSANDRO CILIEGIO NOCE RADICA € 416,78 ANTRACITE € 349,64
 L90 P46 H210	PALISSANDRO D 215 4 98 CILIEGIO D 215 5 98 NOCE D 215 6 98 RADICA D 215 7 98 ANTRACITE D 215 8 98	GUARDAROBA CON RIPIANO E APPENDIABITO L. 90 - P. 46 - H. 210 WARDROBE WITH SHELF AND CLOTH-HANGER L. 90 - W. 46 - H. 210	Kg. 69 Mc. 0,235 Colli. 2 2 Packs	PALISSANDRO CILIEGIO NOCE RADICA € 392,51 ANTRACITE € 325,37

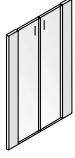

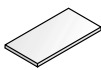
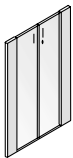
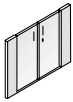
	ART. ITEM	DESCRIZIONE - DESCRIPTION		PREZZO - PRICE
 H. 73 DX - RH	PALISSANDRO D 215 4 43 CILIEGIO D 215 5 43 NOCE D 215 6 43 RADICA D 215 7 43 ANTRACITE D 215 8 43	ANTA BASSA IN LEGNO DX RH LOW WOODEN DOOR	Kg. 4 Mc. 0,020 Colli. 1 1 Pack	PALISSANDRO CILIEGIO NOCE RADICA € 31,50
				ANTRACITE € 25,82
 H. 73 SX - LH	PALISSANDRO D 215 4 44 CILIEGIO D 215 5 44 NOCE D 215 6 44 RADICA D 215 7 44 ANTRACITE D 215 8 44	ANTA BASSA IN LEGNO SX LH LOW WOODEN DOOR	Kg. 4 Mc. 0,020 Colli. 1 1 Pack	PALISSANDRO CILIEGIO NOCE RADICA € 31,50
				ANTRACITE € 25,82
CON SERRATURA WITH LOCK  H. 73	PALISSANDRO D 215 4 46 CILIEGIO D 215 5 46 NOCE D 215 6 46 RADICA D 215 7 46 ANTRACITE D 215 8 46	COPPIA ANTE BASSE IN LEGNO CON SERRATURA LOW WOODEN DOORS PAIR WITH LOCK	Kg. 8 Mc. 0,022 Colli. 1 1 Pack	PALISSANDRO CILIEGIO NOCE RADICA € 65,07
				ANTRACITE € 53,20
 H. 73 DX - RH	PALISSANDRO D 215 4 47 CILIEGIO D 215 5 47 NOCE D 215 6 47 RADICA D 215 7 47 ANTRACITE D 215 8 47	ANTA BASSA IN VETRO DX RH LOW GLASS DOOR	Kg. 4 Mc. 0,020 Colli. 1 1 Pack	PALISSANDRO CILIEGIO NOCE RADICA ANTRACITE € 41,32
 H. 73 SX - LH	PALISSANDRO D 215 4 48 CILIEGIO D 215 5 48 NOCE D 215 6 48 RADICA D 215 7 48 ANTRACITE D 215 8 48	ANTA BASSA IN VETRO SX LH LOW GLASS DOOR	Kg. 4 Mc. 0,020 Colli. 1 1 Pack	PALISSANDRO CILIEGIO NOCE RADICA ANTRACITE € 41,32
SENZA SERRATURA WITHOUT LOCK  H. 73	PALISSANDRO D 215 4 50 CILIEGIO D 215 5 50 NOCE D 215 6 50 RADICA D 215 7 50 ANTRACITE D 215 8 50	COPPIA ANTE BASSE IN VETRO SENZA SERRATURA LOW GLASS DOORS PAIR WITHOUT LOCK	Kg. 8 Mc. 0,022 Colli. 1 1 Pack	PALISSANDRO CILIEGIO NOCE RADICA ANTRACITE € 77,47

	<i>ART. ITEM</i>	<i>DESCRIZIONE - DESCRIPTION</i>		<i>PREZZO - PRICE</i>
 H. 141 DX - RH	PALISSANDRO D 215 4 52 CILIEGIO D 215 5 52 NOCE D 215 6 52 RADICA D 215 7 52 ANTRACITE D 215 8 52	ANTA MEDIA IN LEGNO DX RH MEDIUM WOODEN DOOR	Kg. 9 Mc. 0,029 Colli. 1 1 Pack	PALISSANDRO CILIEGIO NOCE RADICA € 52,16
				ANTRACITE € 34,09
 H. 141 SX - LH	PALISSANDRO D 215 4 51 CILIEGIO D 215 5 51 NOCE D 215 6 51 RADICA D 215 7 51 ANTRACITE D 215 8 51	ANTA MEDIA IN LEGNO SX LH MEDIUM WOODEN DOOR	Kg. 9 Mc. 0,029 Colli. 1 1 Pack	PALISSANDRO CILIEGIO NOCE RADICA € 52,16
				ANTRACITE € 34,09
 H. 141	PALISSANDRO D 215 4 54 CILIEGIO D 215 5 54 NOCE D 215 6 54 RADICA D 215 7 54 ANTRACITE D 215 8 54	COPPIA ANTE MEDIE IN LEGNO MEDIUM WOODEN DOORS PAIR	Kg. 18 Mc. 0,044 Colli. 1 1 Pack	PALISSANDRO CILIEGIO NOCE RADICA € 96,58
				ANTRACITE € 57,84
 H. 141 DX - RH	PALISSANDRO D 215 4 56 CILIEGIO D 215 5 56 NOCE D 215 6 56 RADICA D 215 7 56 ANTRACITE D 215 8 56	ANTA MEDIA IN VETRO DX RH MEDIUM GLASS DOOR	Kg. 8 Mc. 0,029 Colli. 1 1 Pack	PALISSANDRO CILIEGIO NOCE RADICA ANTRACITE € 63,01
 H. 141 SX - LH	PALISSANDRO D 215 4 57 CILIEGIO D 215 5 57 NOCE D 215 6 57 RADICA D 215 7 57 ANTRACITE D 215 8 57	ANTA MEDIA IN VETRO SX LH MEDIUM GLASS DOOR	Kg. 8 Mc. 0,029 Colli. 1 1 Pack	PALISSANDRO CILIEGIO NOCE RADICA ANTRACITE € 63,01
 H. 141	PALISSANDRO D 215 4 58 CILIEGIO D 215 5 58 NOCE D 215 6 58 RADICA D 215 7 58 ANTRACITE D 215 8 58	COPPIA ANTE MEDIE IN VETRO MEDIUM GLASS DOORS PAIR	Kg. 16 Mc. 0,044 Colli. 1 1 Pack	PALISSANDRO CILIEGIO NOCE RADICA ANTRACITE € 120,33

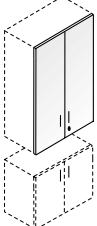
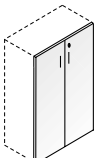
	ART. ITEM	DESCRIZIONE - DESCRIPTION		PREZZO - PRICE
	ANTRACITE D 0240795	RIPIANO SUPPLEMENTARE PER LIBRERIE DA L. 45 ADDITIONAL SHELF FOR 45 CMS. CABINETS	Kg. 3 Mc. 0,008 Colli. 1 1 Pack	€ 13,43
	ANTRACITE D 0240796	RIPIANO SUPPLEMENTARE PER LIBRERIE DA L. 90 ADDITIONAL SHELF FOR 90 CMS. CABINETS	Kg. 7 Mc. 0,015 Colli. 1 1 Pack	€ 18,59
CON SERRATURA WITH LOCK  H. 141	PALISSANDRO D 215 4 60 CILIEGIO D 215 5 60 NOCE D 215 6 60 RADICA D 215 7 60 ANTRACITE D 215 8 60	COPPIA ANTE MEDIE IN VETRO CON SERRATURA MEDIUM GLASS DOORS PAIR WITH LOCK	Kg. 16 Mc. 0,044 Colli. 1 1 Pack	PALISSANDRO CILIEGIO NOCE RADICA ANTRACITE € 133,76
CON SERRATURA WITH LOCK  H. 141	PALISSANDRO D 215 4 62 CILIEGIO D 215 5 62 NOCE D 215 6 62 RADICA D 215 7 62 ANTRACITE D 215 8 62	COPPIA ANTE BASSE IN VETRO CON SERRATURA LOW GLASS DOORS PAIR WITH LOCK	Kg. 8 Mc. 0,022 Colli. 1 1 Pack	PALISSANDRO CILIEGIO NOCE RADICA ANTRACITE € 90,90
ANTA CON SERRATURA DOOR W/LOCK  H. 141 DX - RH	PALISSANDRO D 215 4 64 CILIEGIO D 215 5 64 NOCE D 215 6 64 RADICA D 215 7 64 ANTRACITE D 215 8 64	ANTA MEDIA IN VETRO DX CON SERRATURA RH MEDIUM GLASS DOOR WITH LOCK	Kg. 8 Mc. 0,029 Colli. 1 1 Pack	PALISSANDRO CILIEGIO NOCE RADICA ANTRACITE € 76,44
ANTA CON SERRATURA DOOR W/LOCK  H. 73 SX - LH	PALISSANDRO D 215 4 66 CILIEGIO D 215 5 66 NOCE D 215 6 66 RADICA D 215 7 66 ANTRACITE D 215 8 66	ANTA BASSA IN VETRO SX CON SERRATURA LH LOW GLASS DOOR WITH LOCK	Kg. 4 Mc. 0,020 Colli. 1 1 Pack	PALISSANDRO CILIEGIO NOCE RADICA ANTRACITE € 54,74

	ART. ITEM	DESCRIZIONE - DESCRIPTION		PREZZO - PRICE
 H. 141	PALISSANDRO D 215 4 53 CILIEGIO D 215 5 53 NOCE D 215 6 53 RADICA D 215 7 53 ANTRACITE D 215 8 53	COPPIA ANTE MEDIE IN LEGNO C/SERRATURA IN BASSO MEDIUM WOODEN DOORS PAIR WITH LOCK IN THE BOTTOM PART	Kg. 18 Mc. 0,044 Colli. 1 1 Pack	PALISSANDRO CILIEGIO NOCE RADICA € 107,42
				ANTRACITE € 68,69
 H. 141	PALISSANDRO D 215 4 55 CILIEGIO D 215 5 55 NOCE D 215 6 55 RADICA D 215 7 55 ANTRACITE D 215 8 55	COPPIA ANTE MEDIE IN LEGNO C/SERRATURA IN ALTO MEDIUM WOODEN DOORS PAIR WITH LOCK IN THE UPPER PART	Kg. 18 Mc. 0,044 Colli. 1 1 Pack	PALISSANDRO CILIEGIO NOCE RADICA € 107,42
				ANTRACITE € 68,69

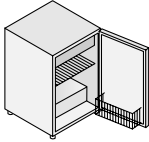
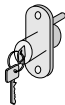
Palissandro Rosewood - Ciliegio Cherry - Noce Walnut - Radica Briar Wood - Antracite Anthracite

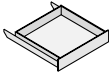
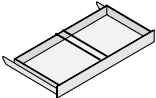
	<i>ART. ITEM</i>	<i>DESCRIZIONE - DESCRIPTION</i>		<i>PREZZO - PRICE</i>
	DX-RH D 0210181 SX-LH D 0210180	FRIGO LT. 50 DA INSERIRE NELLE LIBRERIE BASSE AD 1 ANTA LEGNO 50 LT. REFRIGERATOR TO BE MOUNTED IN LOW CABINETS WITH 1 WOODEN DOOR	Kg. 25 Mc. 0,14 Colli. 1 1 Pack	€ 567,07
	D 0210177	SERRATURA PER ANTE IN LEGNO LOCK FOR WOODEN DOORS	Kg. 0,10 Mc. Colli. 1 1 Pack	€ 7,75
	D 0210178	APPENDIABITO ESTRAIBILE EXTRACTABLE CLOTHANGER	Kg. 0,10 Mc. Colli. 1 1 Pack	€ 11,36
	D 0210172	TELAIO ESTRAIBILE PER CARTELLE SOSEPE ELEMENTI DA L. 45 EXTRACTABLE FRAME FOR HANGING FILE CABINETS L. 45	Kg. 4 Mc. 0,015 Colli. 1 1 Pack	€ 56,29
	D 0210173	TELAIO ESTRAIBILE PER CARTELLE SOSEPE ELEMENTI DA L. 90 EXTRACTABLE FRAME FOR HANGING FILE CABINETS L. 90	Kg. 6 Mc. 0,029 Colli. 1 1 Pack	€ 69,21

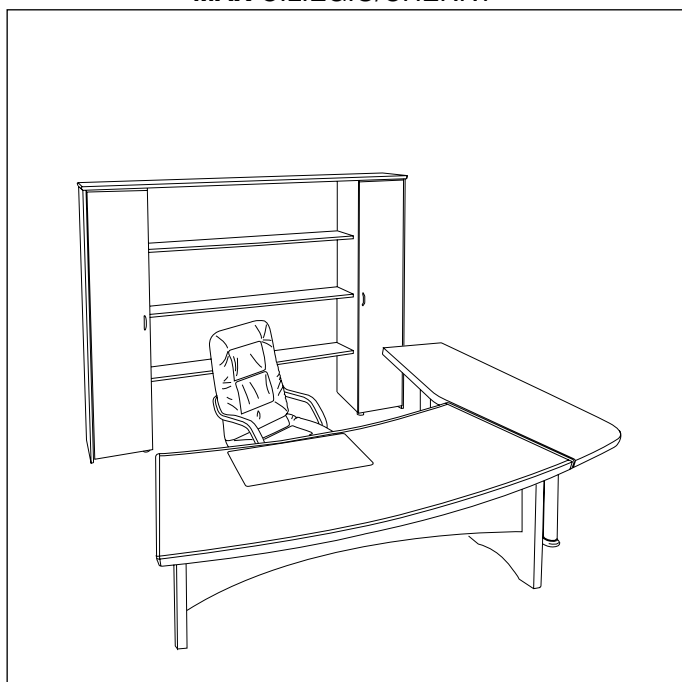
COMPOSIZIONE 520
MAX CILIEGIO/CHERRY

TOT. € 2.676,30
VOLUME: 1,272 M³ - PESO LORDO/Gross Weight: 410,8 Kg
**MOBILI
FURNITURE**

ART.		PREZZO € PRICE €
D215505	NR 1	588,76
D215895	NR 1	416,26
D215596	NR 2	290,77
D215582	NR 1	105,36
D215572	NR 1	134,80
D215587	NR 3	93,48
D218000	NR 1	49,58

TOTALE € 2.176,74
VOLUME: 0,982 M³ - PESO LORDO/Gross Weight: 389 Kg
**SEDUTE
CHAIRS**

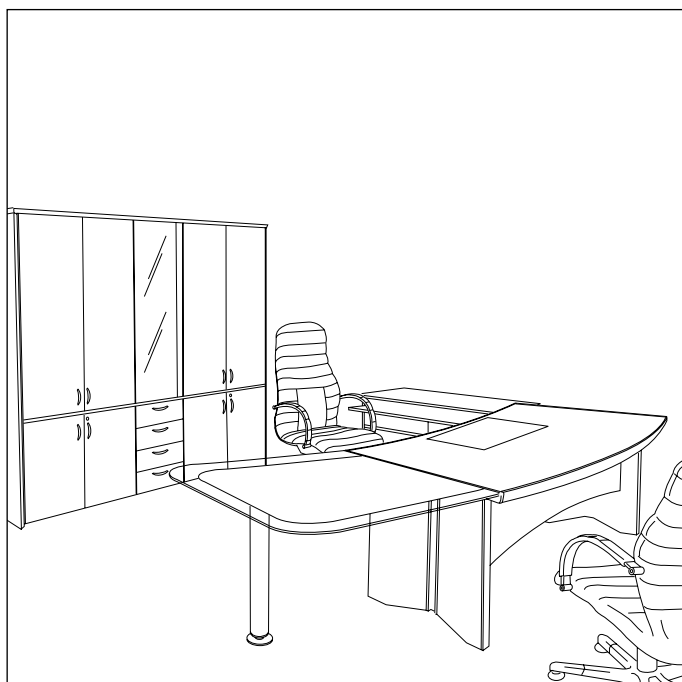
ART.		PREZZO € PRICE €
D29020	NR 1	519,56

TOTALE € 519,56
VOLUME: 0,29 M³ - PESO LORDO/Gross Weight: 21,8 Kg
COMPOSIZIONE 521
MAX NOCE/WALNUT

TOT. € 3.868,26
VOLUME: 2,336 M³ - PESO LORDO/Gross Weight: 558,4 Kg
**MOBILI
FURNITURE**

ART.		PREZZO € PRICE €
D215605	NR 1	588,76
D215612	NR 1	355,84
D0250500	NR 1	336,21
D215628	NR 2	155,97
D215624	NR 1	160,62
D215640	NR 2	228,27
D215637	NR 1	161,65
D215680	NR 1	90,90
D215672	NR 1	134,80
D218000	NR 1	49,58

TOTALE € 2.547,68
VOLUME: 1,684 M³ - PESO LORDO/Gross Weight: 507 Kg
SEDUTE / CHAIRS

ART.		PREZZO € PRICE €
D29010	NR 1	698,25
D29012	NR 1	622,33

TOTALE € 1.320,58
VOLUME: 0,652 M³ - PESO LORDO/Gross Weight: 51,4 Kg

COMPOSIZIONE 522

MAX PALISSANDRO/ROSEWOOD

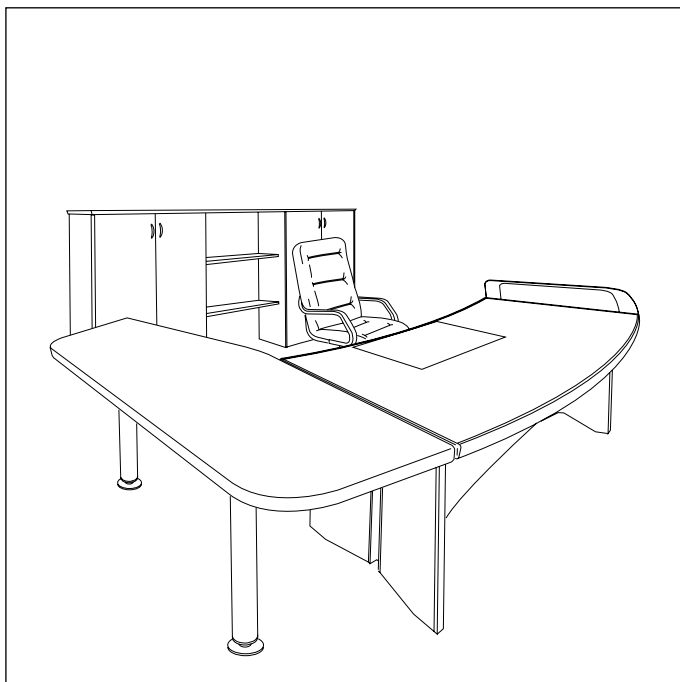

TOT. € 2.691,76

VOLUME: 1,278 M³ - PESO LORDO/Gross Weight: 417,8 Kg

MOBILI FURNITURE

ART.		PREZZO € PRICE €
D215405	NR 1	588,76
D0250500	NR 1	336,21
D218000	NR 1	49,58
D215895	NR 1	416,26
D215440	NR 2	228,27
D215486	NR 2	62,49
D215482	NR 1	105,36
D215470	NR 1	94,51

TOTALE € 2.172,20

VOLUME: 0,988 M³ - PESO LORDO/Gross Weight: 396 Kg

SEDUTE CHAIRS

ART.		PREZZO € PRICE €
D29023	NR 1	519,56

TOTALE € 519,56

VOLUME: 0,29 M³ - PESO LORDO/Gross Weight: 21,8 Kg

COMPOSIZIONE 523

MAX RADICA/BRIAR WOOD

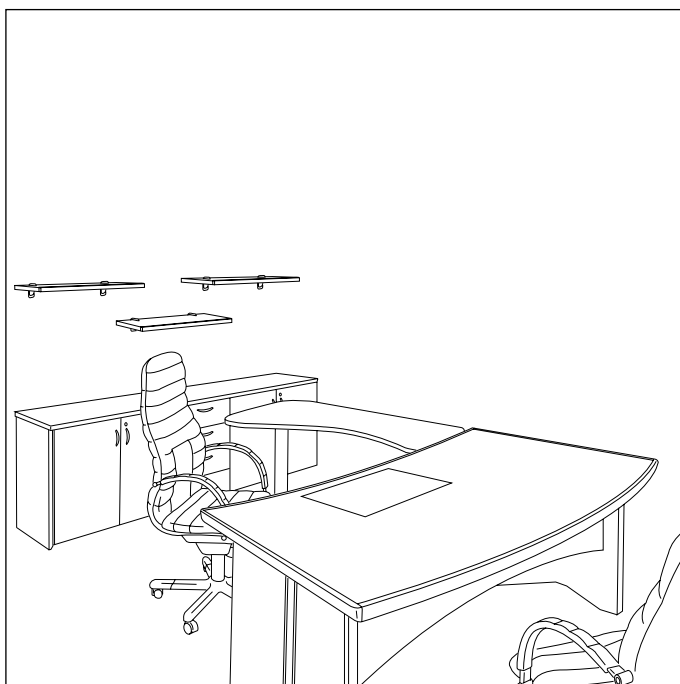

TOT. € 3.061,04

VOLUME: 1,481 M³ - PESO LORDO/Gross Weight: 348,4 Kg

MOBILI FURNITURE

ART.		PREZZO € PRICE €
D215705	NR 1	588,76
D215894	NR 1	270,11
D215880	NR 1	74,89
D215868	NR 1	48,03
D215724	NR 1	160,62
D215728	NR 2	155,97
D218000	NR 1	49,58
D215886	NR 3	62,49

TOTALE € 1.691,40

VOLUME: 0,829 M³ - PESO LORDO/Gross Weight: 297 Kg

SEDUTE CHAIRS

ART.		PREZZO € PRICE €
D29010	NR 1	698,25
D29011	NR 1	671,39

TOTALE € 1.369,64

VOLUME: 0,652 M³ - PESO LORDO/Gross Weight: 51,4 Kg

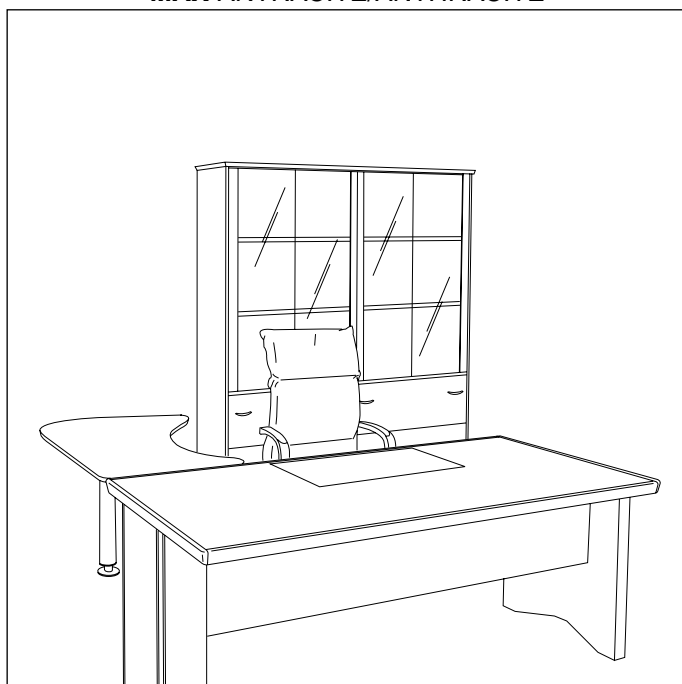
COMPOSIZIONE 524
MAX ANTRACITE/ANTHRACITE

TOT. € 2.357,17
VOLUME: 1,59 M³ - PESO LORDO/Gross Weight: 383,7 Kg
**MOBILI
FURNITURE**

ART.		PREZZO € PRICE €
D215892	NR 1	399,22
D215893	NR 1	270,11
D218000	NR 1	49,58
D215832	NR 2	250,48
D215842	NR 2	252,03
D215878	NR 1	65,59
D215872	NR 1	107,94

TOTALE € 1.897,52
VOLUME: 1,31 M³ - PESO LORDO/Gross Weight: 360 Kg
**SEDUTE
CHAIRS**

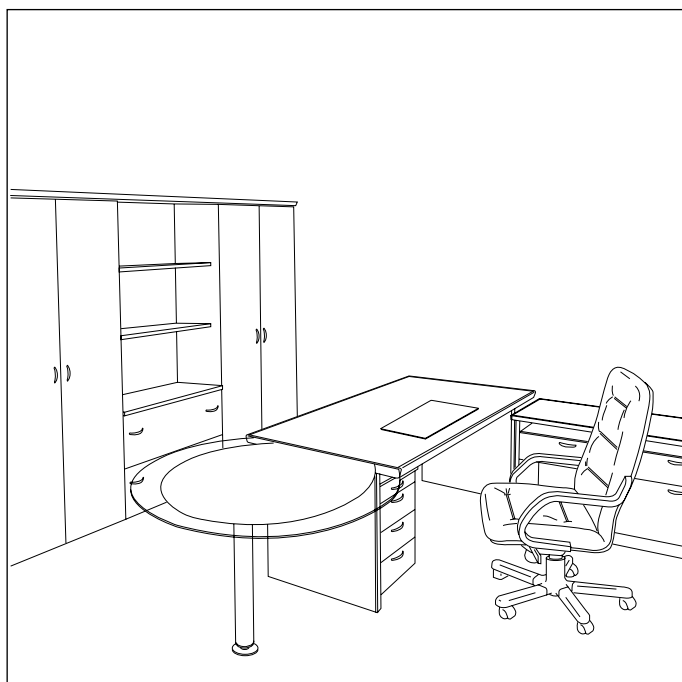
ART.		PREZZO € PRICE €
D29030	NR 1	459,65

TOTALE € 459,65
VOLUME: 0,29 M³ - PESO LORDO/Gross Weight: 23,7 Kg
COMPOSIZIONE 525
MAX NOCE/WALNUT

TOT. € 3.365,24
VOLUME: 2,273 M³ - PESO LORDO/Gross Weight: 481,8 Kg
**MOBILI
FURNITURE**

ART.		PREZZO € PRICE €
D215602	NR 1	391,47
D218000	NR 1	49,58
D0250504	NR 1	336,21
D215612	NR 1	355,84
D215606	NR 1	199,35
D215632	NR 1	264,43
D215697	NR 2	416,78
D215682	NR 1	105,36
D215672	NR 1	134,80
D215684	NR 1	50,10
D215686	NR 2	62,49

TOTALE € 2.845,68
VOLUME: 1,983 M³ - PESO LORDO/Gross Weight: 460 Kg
SEDUTE / CHAIRS

ART.		PREZZO € PRICE €
D29020	NR 1	519,56

TOTALE € 519,56
VOLUME: 0,290 M³ - PESO LORDO/Gross Weight: 21,8 Kg

COMPOSIZIONE 526

MAX CILIEGIO/CHERRY

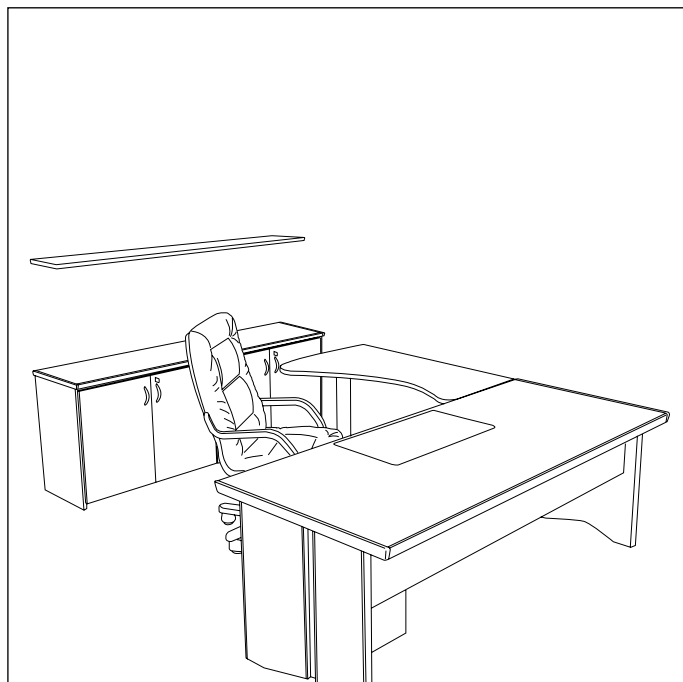

TOT. € 2.516,19

VOLUME: 1,425 M³ - PESO LORDO/Gross Weight: 285,3 Kg

MOBILI FURNITURE

ART.		PREZZO € PRICE €
D215592	NR 1	437,96
D215506	NR 1	199,35
D218000	NR 1	49,58
D215894	NR 1	270,11
D215528	NR 2	155,97
D215578	NR 1	77,47
D215568	NR 1	58,88
D215587	NR 1	93,48

TOTALE € 1.498,77

VOLUME: 0,725 M³ - PESO LORDO/Gross Weight: 248 Kg

SEDUTE CHAIRS

ART.		PREZZO € PRICE €
D29020	NR 1	519,56
D29022	NR 1	497,86

TOTALE € 1.017,42

VOLUME: 0,70 M³ - PESO LORDO/Gross Weight: 37,3 Kg

COMPOSIZIONE 527

MAX PALISSANDRO/ROSEWOOD

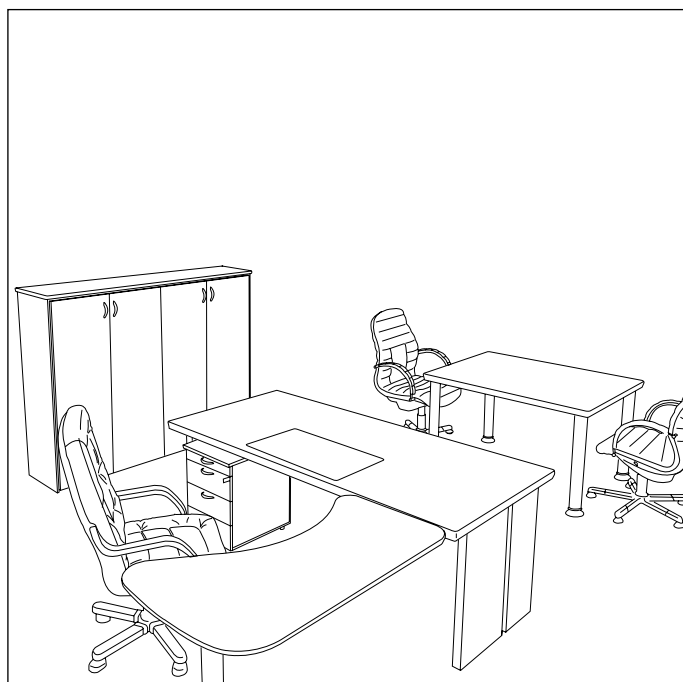

TOT. € 3.670,97

VOLUME: 1,834 M³ - PESO LORDO/Gross Weight: 399,4 Kg

MOBILI FURNITURE

ART.		PREZZO € PRICE €
D215404	NR 1	409,03
D215406	NR 1	199,35
D218000	NR 1	49,58
D215893	NR 1	270,11
D215413	NR 1	350,16
D215440	NR 2	228,27
D215478	NR 1	77,47
D215470	NR 1	94,51

TOTALE € 1.906,75

VOLUME: 0,924 M³ - PESO LORDO/Gross Weight: 328 Kg

SEDUTE CHAIRS

ART.		PREZZO € PRICE €
D29023	NR 1	519,56
D29012	NR 2	622,33

TOTALE € 1.764,22

VOLUME: 0,91 M³ - PESO LORDO/Gross Weight: 71,4 Kg

CONDIZIONI DI VENDITA

- 1) La proposta d'ordine é subordinata all'accettazione della ditta produttrice e deve essere confermata per iscritto. Dovrà essere compilata citando modello, codice, quantità e tutte le altre notizie necessarie per accelerare l'evasione dello stesso.
- 2) I termini di consegna sono sempre indicativi e non impegnano la venditrice. La mancata consegna dovuta a cause di forza maggiore o inadempimento dei termini di pagamento, e/o qualsiasi altro motivo non danno luogo ad alcuna forma di indennizzo o risarcimento.
- 3) La merce viaggia a rischio e pericolo del committente anche se spedita in porto franco. Al committente spetta l'azione di rivalsa nei confronti dei vettori per danni dovuti al trasporto. Tali danni dovranno essere evidenziati sulle bolle di consegna rese firmate al trasportatore.
- 4) Qualsiasi altro reclamo riguardante la merce dovrà essere inoltrato per iscritto entro 8 giorni dal ricevimento della suddetta.
- 5) Non si accettano resi senza previa autorizzazione da parte della ditta venditrice.
- 6) Le vendite si intendono fatte sotto condizione sospensiva (art.1449 cc) rimanendo la merce di proprietà della ditta venditrice sino a che non sia interamente pagata.
- 7) I pagamenti sono validi e liberatori solo se effettuati presso la sede della ditta venditrice nei termini e nelle modalità pattuite. Nel caso di ritardo pagamento decorreranno gli interessi di mora al tasso bancario in vigore.
- 8) I prezzi non contemplano l'I.V.A. e sono modificabili in qualsiasi momento ad insindacabile giudizio della società.
- 9) Per ordini di importo netto superiore ai 400,00 euro la spedizione della merce é in porto franco, per ordini inferiori addebito su fattura di €. 16,00 per contributo spesa trasporto.
- 10) Il presente listino annulla e sostituisce tutti i precedenti. La ditta si riserva il diritto di apportare al prodotto modifiche tecniche ed estetiche al fine di migliorare i propri prodotti, senza preavviso.
- 11) Per qualsiasi controversia, l'esclusivo foro competente é quello della ditta produttrice.

GENERAL SALES CONDITIONS

- 1) The order confirmation is subordinated to the acceptance of the manufacturer and has to be confirmed in writing; it has to be filled in mentioning model, code, quantity and all other information necessary to speed up the carrying out of the order.
- 2) The delivery terms are always indicative and do not bind the seller; the omission delivery due to a cause beyond control, or to the omission of the payment terms, do not give rise to any indemnity.
- 3) The goods are delivered at the customer's risk even if they are sent free port. It is up to the customer the action to the forwarding agent in case of transport damages. The damages must be pointed out on the delivery notes signed by the driver.
- 4) Any other complaint concerning the good must be passed on in writing within 8 days from receipt of the goods.
- 5) Returns of goods without authorization of the manufacturer are not accepted.
- 6) The sales are intended on suspension conditions (art.1449 cc), remaining the goods property of the seller until they are completely paid.
- 7) The payments are valid and discharging only if they are effected at the selling company's seat and in the terms and ways agreed upon. Interests on delayed payment will have effect at the bank rate in force.
- 8) Prices do not include the V.A.T. and can always be modified on unobjectionable trial of the company, and are to be intended ex-works.
- 9) This price list cancels and replaces all previous ones; the company reserves itself the right to make technical and aesthetical changes to the products, in order to improve the production without forewarning.
- 10) For every controversy, the producing company's court of justice is the only competent one.